

## FEATURES & SPECIFICATIONS

**INTENDED USE** — Ideal one-for-one replacement of conventional HID and fluorescent high bay systems. Applications include warehousing, manufacturing, gymnasiums, and other large indoor spaces with mounting heights up to 60'. **Certain airborne contaminants can diminish the integrity of acrylic and/or polycarbonate.** [Click here for Acrylic-Polycarbonate Compatibility table for suitable uses.](#)

**Certain airborne contaminants may adversely affect the functioning of LEDs and other electronic components, including condensation, depending on various factors such as concentrations of the contaminants, ventilation, and temperature at the end-user location.** [Click here for a list of substances that may not be suitable for interaction with LEDs and other electronic components.](#)

**CONSTRUCTION** — Structural elements such as the channel and end caps are fabricated from steel for maximum rigidity. Wireguard attachment points provided. Lightweight aluminum heat sink designed to perform in ambient temperatures up to 55 °C for maximum naturally convective cooling. Optional rotatable outer light modules available when ROTO option is specified, see page 4 for additional details.

**OPTICS** — General, narrow, wide and aisle distributions available to meet both horizontal and vertical light level requirements. Diffuse lens standard to provide glare control and LED protection. Optics are IP5X rated and IK rated. See IK ratings on page 8.

Patent-pending Acuity-exclusive Fresnel pattern molded into lens for crisp distributions and interchangeability in the field.

**ELECTRICAL** — L92 at 60,000 hours. Utilizes a 90°C case temperature driver for maximum life at high temperatures. 0.90 power factor. Luminaire Surge Protection Level: Designed to withstand up to 6kV/3kA per ANSI C82.77-5-2015. Luminaire Surge Protection Level: Designed to withstand up to 10kV/5kA per ANSI C82.77-5-2015, optional. Available as 120-277V or 347-480V input.

0-10V dimming standard for a dimming range of 100% to 10%.

**WIRELESS NETWORKING** — nLight® AIR is the ideal solution for retrofit or new construction spaces where adding additional wiring can be labor intensive and nLight AIR is available with or without an integral sensor. Integrated smart sensors or dimming and switching modules must be part of each luminaire in the nLight AIR network, which can be grouped to control multiple luminaires. The granularity of control with the digital PIR occupancy detection and daylight sensing makes this a great solution for any application.

**INSTALLATION** — Suitable for suspension by chain, cable, surface mounting when using compatible surface mount bracket (THUN accessory ordered separately), and hook monopoint or single (pendant) mount. To maintain ambient listing, fixture should be mounted at a minimum plenum height of 18".

**LISTINGS** — CSA certified to US and Canadian safety standards. Damp location listed. Suitable for ambient temperatures from -40°F (-40°C) to 131°F (55°C) when suspended 18" from ceiling. Note: Temperature cycling, or variations can potentially produce condensation; please consult factory. The Bluetooth® word mark and logos are registered trademarks owned by Bluetooth SIG, Inc. and any use of such marks by Acuity Brands is under license. Other trademarks and trade names are those of their respective owners.

DesignLights Consortium® (DLC) Premium qualified product and DLC qualified product. Not all versions of this product may be DLC Premium qualified or DLC qualified. Please check the DLC Qualified Products List at [www.designlights.org/QPL](http://www.designlights.org/QPL) to confirm which versions are qualified.

**GOVERNMENT PROCUREMENT** — BAA – Product with the BAA option qualifies as a domestic end product under the Buy American Act as implemented in the FAR and DFARS. Product with the BAA option also qualifies as manufactured in the United States under DOT Buy America regulations. BABA – Build America Buy America: Product with the BAA option also qualifies as produced in the United States under the definitions of the Build America, Buy America Act. Please refer to [www.acuitybrands.com/buy-american](http://www.acuitybrands.com/buy-american) for additional information.

**WARRANTY** — 5-year limited warranty. This is the only warranty provided and no other statements in this specification sheet create any warranty of any kind. All other express and implied warranties are disclaimed. Complete warranty terms located at: [www.acuitybrands.com/support/warranty/terms-and-conditions](http://www.acuitybrands.com/support/warranty/terms-and-conditions)

**Note:** Actual performance may differ as a result of end-user environment and application. All values are design or typical values, measured under laboratory conditions at 25 °C. Specifications subject to change without notice.

### Stock configurations are offered for shorter lead times:

Standard Part Number	Stock Part Number	DLC QPL Product ID	DLC Premium?
IBG 12000LM SEF AFL GND MVOLT GZ10 40K 80CRI DWH	IBG 12L MVOLT	PAMMN2VX	✓
IBG 15000LM SEF AFL GND MVOLT GZ10 40K 80CRI DWH	IBG 15L MVOLT	P3G6HADN	✓
IBG 18000LM SEF AFL GND MVOLT GZ10 40K 80CRI DWH	IBG 18L MVOLT	P851GVEP	✓
IBG 24000LM SEF AFL GND MVOLT GZ10 40K 80CRI DWH	IBG 24L MVOLT	PZBJQY5S	✓
IBG 12000LM SEF AFL GND MVOLT GZ10 50K 80CRI DWH	IBG 12L MVOLT 5K	P7TZAZV	✓
IBG 15000LM SEF AFL GND MVOLT GZ10 50K 80CRI DWH	IBG 15L MVOLT 5K	PMXBGZJS	✓
IBG 18000LM SEF AFL GND MVOLT GZ10 50K 80CRI DWH	IBG 18L MVOLT 5K	P85EZU7	✓
IBG 24000LM SEF AFL GND MVOLT GZ10 50K 80CRI DWH	IBG 24L MVOLT 5K	PQ5CSK48	✓

Catalog Number
Notes
Type



LED High Bay

# IBG



### Embed nLight controls today. Prepare for tomorrow.

#### Now

- User-friendly install
- Enhanced energy savings
- Code compliance

#### Tomorrow

- Scalability
- Space configuration
- Future-ready



Items marked by a shaded background qualify for the Design Select program and ship in 15 days or less. To learn more about Design Select, visit [www.acuitybrands.com/designselect](http://www.acuitybrands.com/designselect). \*See ordering tree for details

### A+ Capable Luminaire

This item is an A+ capable luminaire, which has been designed and tested to provide consistent color appearance and out-of-the-box control compatibility with simple commissioning when used with Acuity Brands controls products. *All configurations of this luminaire are calibrated and tested to meet the Acuity Brands' specifications for chromatic consistency – including color rendering, color fidelity, and color temperature tolerance around standard CIE chromaticity coordinates.*

To learn more about Acuity A+ standards, specifications, and testing visit [www.acuitybrands.com/aplus](http://www.acuitybrands.com/aplus).

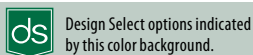

**ORDERING INFORMATION**

Lead times will vary depending on options selected. Consult with your sales representative.

**Example:** IBG 24000LM SEF AFL GND MVOLT GZ10 40K 80CRI DWH

Series	Lumen package	Performance package	Lens	Distribution	Voltage	Driver	Color temperature	Coloring rendering index
IBG	8000LM 8,000 lumens ‡	SEF Standard efficiency	AFL Acrylic, frosted	GND General	MVOLT 120-277V	GZ10 0-10V dimming	35K 3500 K	70CRI 70 CRI
	12000LM 12,000 lumens		ACL Clear acrylic					
	15000LM 15,000 lumens	HEF Premium efficiency	PCL Clear polycarbonate		120 120V		50K 5000 K	90CRI 90 CRI ‡
	18000LM 18,000 lumens		PFL Semi-diffuse polycarbonate		208 208V			
	24000LM 24,000 lumens		L/LENS Less lens ‡	ND Narrow WD Wide ADL Rack	240 240V			
	30000LM 30,000 lumens		277 277V					
	36000LM 36,000 lumens ‡		347 347V ‡					
	48000LM 48,000 lumens ‡		480 480V ‡					
	60000LM 60,000 lumens ‡							
	72000LM 72,000 lumens ‡							

Options		Finish
BAA Buy America(n) Act and/or Build America Buy America Qualified	Individual Controls (LSXR): ‡	DNA Natural aluminum
Emergency batteries ‡	LSXR6 360° integral high mount motion sensor with standard on/off operation (formerly LAOZU) <a href="#">LINK</a>	DWH Gloss white
E10W IOTA 10W emergency battery pack, Constant Power, Certified in CA Title 20 MAEDBS, Self-diagnostics ( <a href="#">LINK</a> ) ‡	LSXR6 HL 360° integral high mount motion sensor with high/low/(Off) occupancy operation (formerly LAHOSZU) (For High/Low only)	MB Matte black
IE20WCPHE Iota 20W emergency battery pack, Certified in CA Title 20 MAEDBS ‡	LSXR6 P 360° integral high mount motion sensor with On/Off switching photocell (formerly LAPZU)	
IE30WCPHE Iota 30W emergency battery pack, Certified in CA Title 20 MAEDBS ‡	LSXR6 ADC 360° integral high mount motion sensor with On/Off occupancy operation with auto dimming photocell. (formerly LAMOSZU)	
SPD Surge protection device ‡	LSXR6 ANL 360° integral high mount motion sensor with High/Low occupancy and auto dimming / off functionality due to photocell	
ETS Generator transfer device ‡	*For 360° integral Low Mount sensors, replace "6" in nomenclature with "10". For High Mount Aisleway sensors, replace "6" in nomenclature with "50". Ex: LSXR10 ADC	
SF Single fuse ‡	Individual Controls with Bluetooth Programming (Haleon) ‡	
DF Double fuse ‡	HLN45 OCC 360° integral high mount motion sensor; Bluetooth enabled <a href="#">LINK</a> (formerly HLN360)	
OUTCTR Wiring leads pulled through back center of fixture ‡	HLN45 HL 360° integral high mount motion sensor with High/Low (Off) occupancy detection; Bluetooth enabled (formerly HLN360HL)	
OCS RELOC® OnePass® selectable cable 6' installed ‡ ‡	HLN45 ADC 360° integral high mount motion sensor. High / Low / Off occupancy operation with photocell; Bluetooth enabled (formerly HLN360ADC)	
OCS4C RELOC® One Pass® selectable cable 6' installed. ‡ ‡	HLN45 ANL 360° integral high mount motion sensor with High/Low occupancy and auto dimming / off functionality due to photocell; Bluetooth enabled (formerly HLN360ANL)	
OCU___ RELOC® OnePass® unselectable cable 6' installed (must specify tap position) ‡	*For integral Aisle Mount sensors, replace "45" in nomenclature with "45A". Ex: HLN45A ADC	
IMP Integrated modular plug ‡	nLight Wired Network Controls	
RRL___ RELOC®-Ready luminaire. (Not available with Haleon sensor options) See page 16 for ordering information ‡	NCMB6 nLight High Mount Occupancy Sensor with Dimming, pre-wired <a href="#">LINK</a> (Includes dimming Power Pack) ‡	
WGX Standard wire guard, installed (not available with Haleon sensor)	NPP16 D nLight dimming & switching module <a href="#">LINK</a> ‡	
ROTO Rotateable optics ‡	*For 360° integral Low Mount sensors, replace "6" in nomenclature with "10". For high Aisle Mount sensors, replace "6" with "50". Ex: NCMB50	
JP Job Pack Packaging (Consult table on page 11 for details)	nLight AIR Wireless Controls ‡	
Cord sets ‡	NLTAIR2 RLSXR6 nLight AIR (wireless) gen 2 control device with high mount occupancy and daylight sensor	
CPSBW 6' white damp location cord with straight blade plug (voltage will match fixture, 120V or 277V only)	NLTAIR2 RLSXR10 nLight AIR (wireless) gen 2 control device with low mount occupancy and daylight sensor	
CPTLW 6' white damp location cord with twist-lock plug (voltage will match fixture) ‡	*For High Mount AISLEWAY sensors, replace "6" in nomenclature with "50". Ex: RLSXR50	
CNPW 6' white cord, no plug	NLTAIR2 RMSOD45 Embedded nLight AIR (wireless) gen 2 control device with high mount occupancy and daylight sensor <a href="#">LINK</a>	
CNP4CW 6' white cord with 4 conductors, no plug (for use when unswitched hot is required for battery pack)	NLTAIR2 RIO nLight AIR (wireless) gen 2 control device (dimming & switching) <a href="#">LINK</a>	
CNP5CW 6' white cord, 5 conductor, no plug, damp location	*For 360° integral Low Mount sensors, replace "45" in nomenclature with "7". For high Aisle Mount sensors, replace "45" with "45A". Ex: NLTAIR2 RMSOD45A	
CNP5CDW 6' white cord, 5 conductors (for bringing dimming leads out of fixture)	**For guidance on which sensors to use with emergency generator power, consult table on page 10.	

NOTE: ‡ ‡ indicates option chosen has ordering restrictions. Please reference ordering restrictions chart, page 4. Options are sorted alphanumerically.

See Accessories and option value restrictions on next page

Accessories: Order as separate catalog number.		
<b>Mounting:</b>		
IBAC120 M100	Aircraft cable 10' with hook (one pair)	CS1WIMP Straight plug, 120V
IBAC240 M75	Aircraft cable 20' with hook (one pair)	CS3WIMP Twist-lock, 120V
IBHMP	Hook monopoint	CS7WIMP Straight plug, 277V
HBBS36	Chain hanger with chain, 36" (one pair)	CS11WIMP Twist-lock, 277V
IBGACVH	Aircraft 10' V hanger (one pair)	CS25WIMP Twist-lock 347V
IBGPMPHB	Pendant monopoint splice box, includes side covers (3/4" hub) for use with OUTCTR option, not available with backpack ‡	CS93WIMP 600V SO white cord, no plug (no voltage required)
THUN	Tong hanger bracket (order 2 per fixture) ‡	CS97WIMP Twist-lock 480V
		MSIIMPBG Aisle sensor for use with IMP option
		MSI360IMPBG 360° sensor for use with IMP option
		<b>*Base fixture must be ordered with IMP option when ordering this accessory.</b>
		<b>Wire guards (gloss white*) - not available with Haleon sensor</b>
		<b>SEF Lumen Packages</b>
		<b>HEF Lumen Packages</b>
		WGIBG22 8000LM, 12000LM, 15000LM 8000LM
		WGIBG24 18000LM, 24000LM, 30000LM 12000LM, 15000LM
		WGIBG26 36000M 18000LM, 24000LM, 30000LM, 36000LM
		WGIBG44 48000LM, 60000LM -
		WGIBG46 72000LM 48000LM, 60000LM, 72000LM
		*For DNA wire guards, add DNA to end of nomenclature. Ex: WGIBG26DNA
		*For MB wire guards, add MB to end of nomenclature. Ex: WGIBG26MB

**CORD SET ORDERING INFORMATION** Cord sets cannot be ordered as accessories

Plug Option	Plug type	Amperage**	Gauge	# of conductors	Color	Location	Length
CNP Cord Only	(blank) No Plug Option (for Cord Only option)	(blank) 15 amps	(blank) 18 gauge standard	(blank) 3 conductors (blk/wht/grn)	(blank) Black	(blank) Damp Location	(blank) 6 feet
CP Cord with Plug	TL Locking Type	20A 20 amps***		4C 4 conductors; Use with Battery option when unswitched hot is needed	W White		3FT 3 feet
	SB Straight blade*			5C 5 conductors; Use when fixture has 2 drivers and separate operation is required			10FT 10 feet
				5CD 5 conductors; Use with dimming driver when dimming leads are desired (Not for use with dimming sensors)****			12FT 12 feet
							15FT 15 feet
							20FT 20 feet

\* Not available wet location. Not available with 347 and 480 volt configurations.

\*\* Amperage is only configurable for cords with plugs.

\*\*\* Required on 347 and 480 volt configurations.

\*\*\*\* Not available with plugs.

‡ Option Value Ordering Restrictions	
Option value	Restriction
347	Not available with ETS,nPP16 D, E10W, EM or ER sensor solutions.
36000LM	When ordering 347V or 480V with NLTAIR2 or Haleon, <b>fixture utilizes backpack adding 3.09" depth to fixture (see page 9 for line art)</b> . Not available with HVOLT, Haleon, or NLTAIR2 options and a battery pack when ordered in combination.
3ND	Available with ACL and L/Lens options only.
480	Not available with ETS,nPP16 D, E10W, EM or ER sensor solutions.
48000LM	When using IBGPMPHB, mono-point bracket mounts off-center, requiring aircraft cables for additional fixture support and fixture leveling. Must use additional method such as flexible conduit (supplied by others) to bring wiring to pendant mono-point when using for wiring box.
60000LM	When using IBGPMPHB, mono-point bracket mounts off-center, requiring aircraft cables for additional fixture support and fixture leveling. Must use additional method such as flexible conduit (supplied by others) to bring wiring to pendant mono-point when using for wiring box.
72000LM	When using IBGPMPHB, mono-point bracket mounts off-center, requiring aircraft cables for additional fixture support and fixture leveling. Must use additional method such as flexible conduit (supplied by others) to bring wiring to pendant mono-point when using for wiring box.
8000LM	When ordering 347V or 480V with NLTAIR2 or Haleon option, <b>fixture utilizes backpack adding 3.09" depth to fixture (see page 9 for line art)</b> . Not available with HVOLT, Haleon, or NLTAIR2 options and a battery pack when ordered in combination.
90CRI	Only available with SEF. 90CRI configurations have longer lead times.
Cord sets	Must specify voltage on cord sets with plugs (not available with MVOLT or HVOLT). 347 and 480 cordset with twistlock plugs require 20A. Straight blade plugs are not available with 347 or 480 volts. Refer to cord set ordering table, page 3 for more configurations. Non-standard configurations have extended lead times. CNP5CW is not available with any sensors. CNP5CDW is not available with sensors that have dimming options.
DF	Available on 208, 240, 480V. Not available with MVOLT or HVOLT.
E10W	Only available with 8000LM. MVOLT only. Not available with IMP option. <b>Fixture utilizes backpack, adding 3.08" to fixture depth (see page 9 for line art)</b> .
Emergency batteries	Not available with IMP option. Emergency batteries alter fixture construction, (see pg. 9 for batteries that use a backpack and line art) Not available with cords with plugs. Use CNP4CW or OCS4C when unswitched hot is required for batter pack options. Consult standard wiring detail on page 9.
ETS	MVOLT only. Not available with cord sets or batteries. When sensor is required, please use the ER sensor option (reference page 9). When ordered with 72000LM, fixture cannot be surface mounted (THUN brackets). Consult table on page 7 for max operating temperature. Utilizes <a href="#">ETS20 DR</a> for 72000LM and <a href="#">ETS 924 DR</a> for all others.
HVOLT	Not available with ETS,nPP16 D, E10W, EM or ER sensor solutions.
IBGPMPHB	When using with 48000LM, 60000LM, or 72000LM, mono-point bracket mounts off-center, requiring aircraft cables for additional fixture support and fixture leveling. Must use additional method such as flexible conduit (supplied by others) to bring wiring to pendant mono-point when using for wiring box.
IE20WCPHE	Not available with 8000LM or IMP option. <b>Battery adds 2.8" depth to fixture (see page 9 for line art)</b> .
IE30WCPHE	Not available with 8000LM or IMP option. <b>Battery adds 2.8" depth to fixture (see page 9 for line art)</b> .
IMP	Must specify voltage. Not available with NLight wired sensors or any dimming sensor, batteries, or OUTCTR option. Fixture requires IMP power cord accessory. Not for use with THUN mounting accessory.
Individual controls (Haleon)	Refer to page 13 for Haleon sensor default settings matrix. When ordered with ER sensor, ETS is used. Not available with other controls. Low temperature (LT) option standard, do not call out.
Individual controls (LSXR)	Comes standard with SPD. This sensor configuration is suitable for minimum ambient temperature of 14°F (-10°C). When ordered with ER sensor, ETS is used. Not available with other controls. Refer to page 14 for additional LSXR ordering options. Not available with CNP5CW or CNP5CDW
NLTAIR2 RLSXR6, NLTAIR2 RLSXR10	Can be used as a normal power sensing device for nLight AIR devices and other luminaires with EM emergency options. May not be used for emergency operation if EM or ER options are added. See Emergency Operation Scenarios chart for more information.
L/LENS	Lens is always recommended.
NCMB6	Sensor wired via CAT5 to nPP16 D dimming power pack. CAT5e connector cable also included. Ships standard with SPD. Only available with 120, 277 or 347V. Not available with other controls.
nPP16 D	Not for use with THUN accessory. Ships standard with SPD. Only available with 120, 277, or 347V. Not available with IMP or nLight wireless options.
OCS	Must specify voltage. Fixture will bear dry location label. Order OCS10 for 10' cord. Consult standard wiring detail on page 9.
OCS4C	Fixture will bear a dry location label. Use when unswitched hot is required for battery pack options, consult standard wiring detail on page 9. Available with 120, 277 and 347 Volts only.
OCU_	Must specify voltage. When 0-10V dimming leads are required, use C12S option. C12S option is not available with dimming sensors. Fixture will bear dry location label.
OUTCTR	Not available with emergency batteries. Requires IBGPMPHB accessory to mount fixture. Not available with cord set, ETS and IMP options.
ROTO	Available with IBG 8000LM, 12000LM, 15000LM, 18000LM, 24000LM, 30000LM or 36000LM only.
RRL	When dimming leads are required use C12S option. Not for use with dimming sensors.
SF	Available on 120, 277, 347V. Not available with MVOLT or HVOLT.
SPD	Standard with HVOLT, 347, 480, ETS, E10W, IE20WCPHE HVOLT, IE30WCPHE HVOLT, LSXR, NPP16 D, NPP16 D ER and RPP20 D EM options. Standard with 8000LM when ordered with Haleon and NLTAIR2. Only specify MVOLT, 120, 208, 240, or 277V when additional surge protection is needed.
THUN	Maximum ambient temperature of standard fixture mounted with THUN is 113°F (45°C). Not available with MSIMPIBG, MSI360IMPIBG, NPP16 D options. Not available with 72000LM with ETS. Not for use with IMP option. Not for use with battery packs.

‡ Design Select Ordering Restrictions	
Option Value	Ordering Restrictions
OCS, OCS4C (all lengths)	Not on program when combined with 120V, 208V, 240V, or 347V
CPTLW	Not on program when combined with 208V, 240V, or 347V



## ROTATABLE OPTICS

- Rotate in 30° increments, 0° - 180°
- Create Custom Distributions
- 30° - light up rack
- 90° - wall wash
- 180° - Uplight

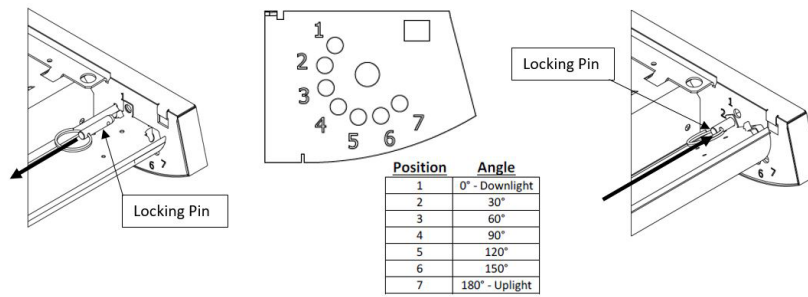

## HANGER HOLE DIMENSIONS

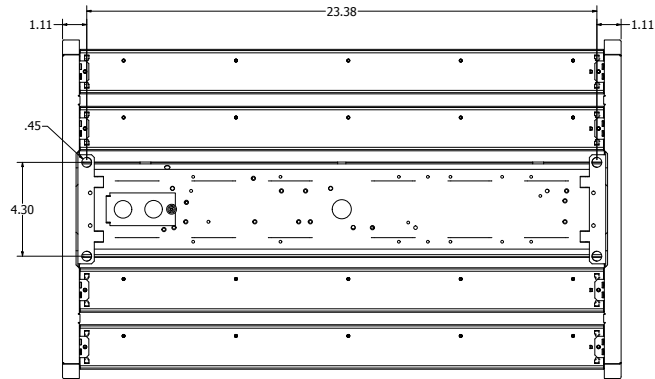

## LINE ART AND DIMENSIONS

All dimensions are in inches (centimeters) unless otherwise indicated.  
Dimensions may vary with options or accessories.

### IBG SEF DIMENSIONS

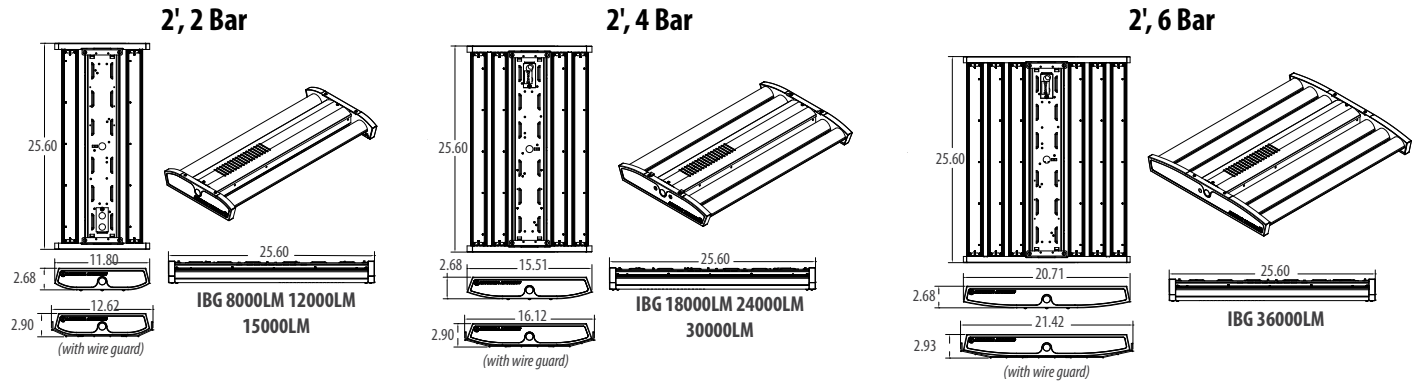

Weight: (may vary with options or accessories)

- 8L/12L/15L: 7.75 lbs (3.515Kg)
- 18L/24L/30L: 10.5 lbs (4.762Kg)
- 36L: 15.9 lbs (7.212Kg)
- 48L/60L: 20 lbs (9.07Kg)
- 72L: 21.75 lbs (9.865Kg)

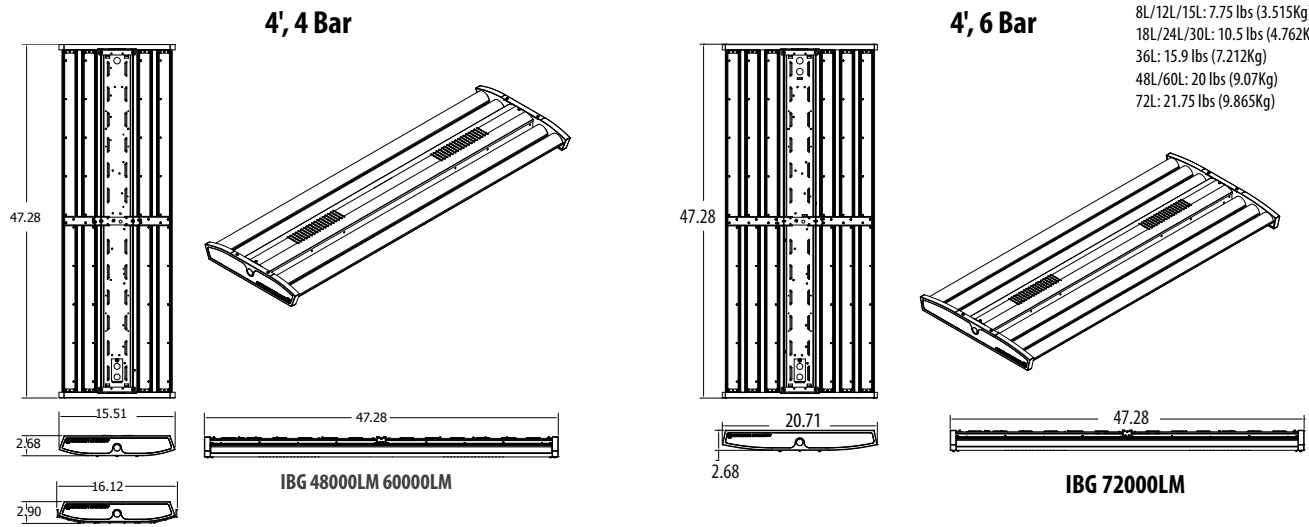

### IBG HEF DIMENSIONS

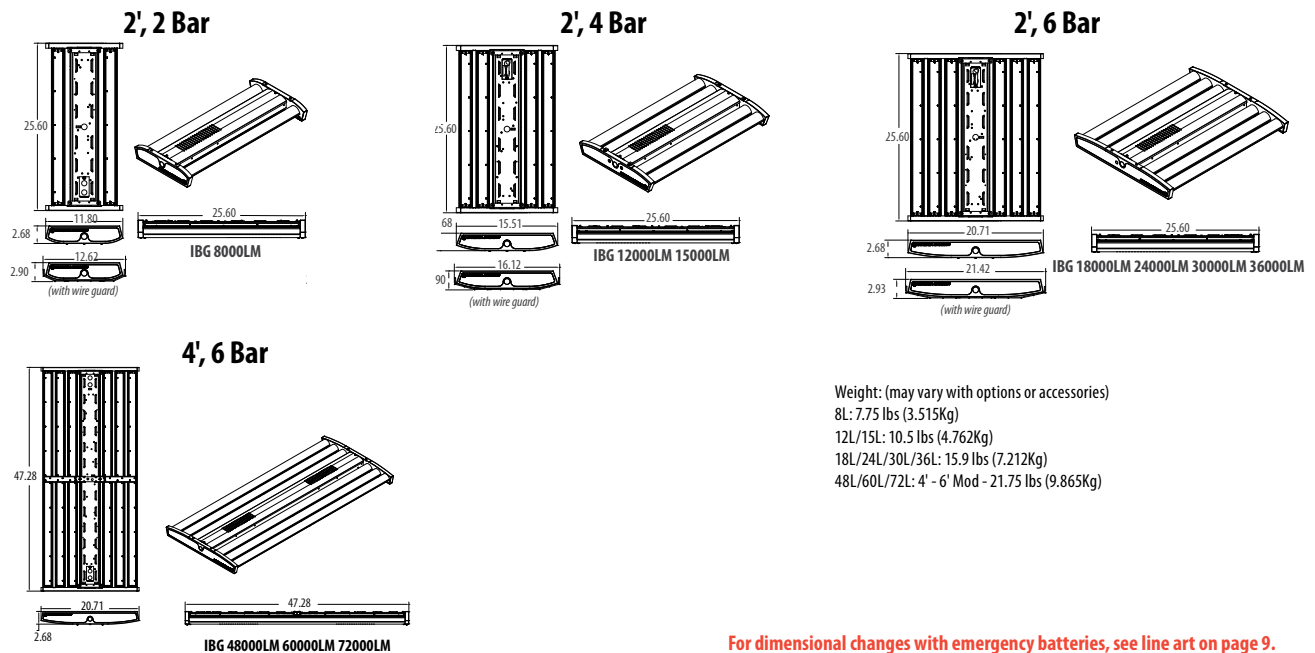

Weight: (may vary with options or accessories)

- 8L: 7.75 lbs (3.515Kg)
- 12L/15L: 10.5 lbs (4.762Kg)
- 18L/24L/30L/36L: 15.9 lbs (7.212Kg)
- 48L/60L/72L: 4' - 6' Mod - 21.75 lbs (9.865Kg)

For dimensional changes with emergency batteries, see line art on page 9.

**IBG OPERATIONAL DATA**

IBG SEF			AFL GND	
			Acrylic Frosted, General	
Lumen Package	Wattage (277V)	Lumen Output	LPW	
Delivered Lumens 4000K, 80CRI SEF	8000LM	48	7845	163
	12000LM	76	11856	156
	15000LM	93	14774	159
	18000LM	105	18531	176
	24000LM	144	24490	170
	30000LM	178	29586	166
	36000LM	218	35451	163
	48000LM	284	47261	166
	60000LM	357	59715	167
72000LM	426	71168	167	
Delivered Lumens 5000K, 80CRI SEF	8000LM	48	7970	165
	12000LM	76	12045	158
	15000LM	93	15010	161
	18000LM	105	18297	174
	24000LM	144	25046	174
	30000LM	178	30059	169
	36000LM	218	36018	165
	48000LM	284	48017	169
	60000LM	357	60670	170
72000LM	426	72306	170	

IBG HEF			AFL GND	
			Acrylic Frosted, General	
Lumen Package	Wattage (277V)	Lumen Output	LPW	
Delivered Lumens 4000K, 80CRI HEF	8000LM	47	7913	167
	12000LM	68	11944	176
	15000LM	85	14941	176
	18000LM	100	17902	179
	24000LM	134	23845	178
	30000LM	170	29819	175
	36000LM	214	35900	168
	48000LM	280	47662	170
	60000LM	343	57621	168
72000LM	425	71124	167	
Delivered Lumens 5000K, 80CRI HEF	8000LM	47	8092	171
	12000LM	68	12215	180
	15000LM	85	15280	180
	18000LM	100	18308	183
	24000LM	134	24386	182
	30000LM	170	30495	179
	36000LM	214	36715	172
	48000LM	280	48744	174
	60000LM	343	58929	172
72000LM	425	72738	171	

**SCALING FACTOR TABLES**

CCT	Multiplier
3000K	0.93
3500K	0.96
4000K	0.98
5000K	1.00

CRI	Multiplier
70CRI	1.05
80CRI	1.00
90CRI	0.87

General Distributions	Multiplier
AFL GND	1.00
ACL GND	1.01
PFL GND	0.83
L/Lens	1.04

Other Distributions	Multiplier
AFL GND	1.00
ATL ND	1.00
ATL WD	1.00
ATL AD	1.01

**PHOTOMETRICS**

See [www.lithonia.com](http://www.lithonia.com).

**IBG CHARACTERISTICS**

Lumen package	Wattage								Length	Width	Depth	Comparable Light Source
	Standard efficiency				High efficiency							
	120V	277V	347V	480V	120V	277V	347V	480V	Dimensions are shown in inches (centimeters) unless otherwise noted. Dimensions are for SEF fixtures.			
8000LM	48	48	48	48	47	47	47	47	25.6	11.8	2.75	100W MH, 4-lamp T8 NBF
12000LM	77	76	75	75	69	68	67	68	25.6	11.8	2.75	175W MH, 4-lamp T8 HBF, 2-lamp T5HO
15000LM	95	93	93	93	86	85	85	85	25.6	11.8	2.75	200W MH, 6-lamp T8 NBF
18000LM	106	105	106	105	100	100	99	99	25.6	15.51	2.75	250W MH, 6-lamp T8 HBF, 4-lamp T5HO
24000LM	147	144	145	145	135	134	134	135	25.6	15.51	2.75	400W MH, 6-lamp T5HO
30000LM	182	178	179	179	172	170	171	171	25.6	15.51	2.75	575W MH, 10-lamp T8 HBF
36000LM	223	218	217	217	214	214	214	213	25.6	20.65	2.75	750W MH, 8-lamp T5HO
48000LM	290	284	287	285	280	280	279	278	47.29	15.51	2.75	875W MH, 10-lamp T5HO
60000LM	365	357	361	359	346	343	344	345	47.29	15.51	2.75	1000W MH
72000LM	435	426	431	428	428	425	426	427	47.29	20.65	2.75	1000W MH

**PROJECTED LUMEN MAINTENANCE**

IBG 2ft & 4ft						
Operating hours	0	15,000	30,000	45,000	60,000	100,000
Lumen maintenance factor	1	0.98	0.96	0.94	0.92	0.86

**IK RATING**

IK Rating	
Poly-carbonate Lens	IK10
Acrylic Lens	IK06

**AMBIENT TEMPERATURE RATINGS**

LUMENS	SUSPENDED	SUSPENDED SENSORS/ CONTROL	SURFACE	SURFACE SENSORS/ CONTROL	BATTERY	ETS
8000LM	55	55	45	45	45	40
12000LM	55	55	45	45	40	40
15000LM	55	55	45	45	40	40
18000LM	55	55	45	45	40	40
24000LM	55	55	45	45	40	40
30000LM	55	55	45	45	40	40
36000LM	55	55	45	45	40	40
48000LM	55	55	45	45	40	40
60000LM	55	55	45	45	40	40
72000LM	55	55	45	45	40	40

**LUMENS VS. AMBIENT TEMPERATURE**

Ambient °C	Ambient °F	Lumen Multiplier
0	32	1.03
5	41	1.03
10	50	1.02
15	59	1.01
20	68	1.01
25	77	1
30	86	0.99
35	95	0.99
40	104	0.98
45	113	0.97
50	122	0.96
55	131	0.95

**Note:** Various add-on components such as sensors and batteries impact operating temperature range of IBG fixture. Consult component specification sheets or consult factory to determine if components have a different operating temperature range than IBG.

**EMERGENCY BATTERY PACK OPTIONS**

Factory-Installed Nomenclature	Battery Part Number	Factory installed on back of fixture	Suitable for Field Installation
E10W	<a href="#">ILD 10</a>	Yes	No
IE20WCPHE (with MVOLT)	<a href="#">ILBLP-CP20-HE-SD-HV</a>	Yes	Yes
IE30WCPHE (with MVOLT)	<a href="#">ILBLP-CP30-HE-SD-HV</a>	Yes	Yes
IE20WCPHE (with HVOLT)	<a href="#">ILBHI-CP20-HE-SD-HV</a>	Yes	Yes
IE30WCPHE (with HVOLT)	<a href="#">ILBHI-CP30-HE-SD-HV</a>	Yes	Yes

Note: ILBHI is standard HVOLT battery pack

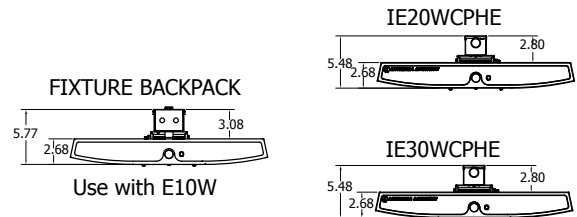

**CORD SETS WITH EMERGENCY WIRING DETAILS**

When battery is ordered with a 3-conductor cord set or Reloc® cord (OCS):

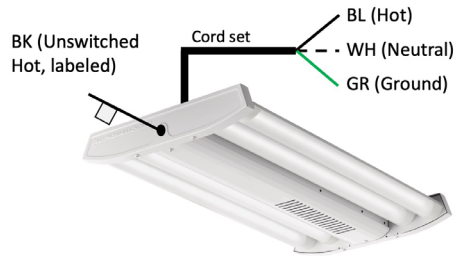

The 3 conductor cord set will include the hot (BL), neutral (WH), and ground (GR) conductors but not the unswitched hot for the battery.

- The unswitched hot for powering the battery (BK) will exit the fixture out of the KO of the backpack (for E10WCP batteries) or out of the KO on the end plate (all other battery options).
- If KO-mounted sensor is included, the unswitched hot will come out of opposite end plate KO.

When battery is ordered with a 4-conductor cord set or Reloc® cord (OCS4C):

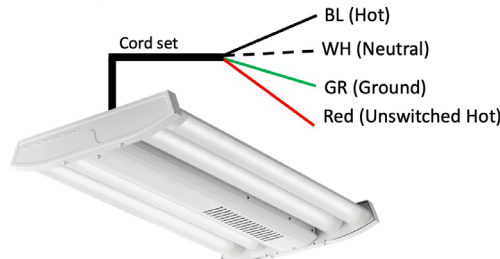

The 4 conductor cord set will include include the hot (BL), neutral (WH), and ground (GR) conductors AND the unswitched hot will be a separate conductor (RED).

**Note:** To get IBG wired from the factory for 24/7 operation, with on/off controlled by sensor rather than switch, contact your factory representative to request the normal hot and unswitched hot wired together in the fixture. Consult local codes to determine if this is allowable.

When ETS is used (individually or on ER sensor) with a 3-conductor cord set or Reloc® cord (OCS):

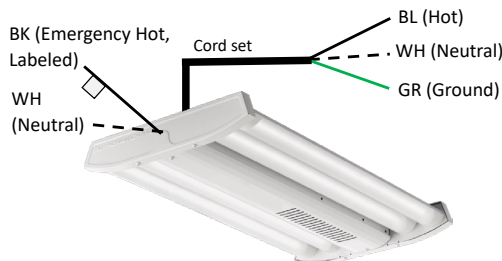

The 3 conductor cord set will include the hot (BL), neutral (WH), and ground (GR) conductors but not the dedicated hot and neutral for emergency function

- The emergency hot (BK) and neutral (WH) will exit the fixture out of the KO of the end plate.
- If KO-mounted sensor is included, the emergency hot and neutral will come out of opposite end plate KO.

**EMERGENCY LUMENS AFL GND (5000K 80CRI)**

		E10W	IE20WCPHE	IE30WCPHE
SEF	8000	2000	-	-
	12000	-	3900	5800
	15000	-	3900	5800
	18000	-	3900	5800
	24000	-	4000	6000
	30000	-	4000	6000
	36000	-	4000	6000
	48000	-	4000	6000
	60000	-	4000	6000
72000	-	4000	6000	

		E10W	IE20WCPHE	IE30WCPHE
HEF	8000	2100	-	-
	12000	-	4200	6200
	15000	-	4200	6200
	18000	-	4300	6300
	24000	-	4300	6300
	30000	-	4300	6300
	36000	-	4300	6300
	48000	-	4300	6300
	60000	-	4300	6300
72000	-	4100	6100	

**Note:** Based on AFL GND, 50K, 80CRI. For emergency lumen output of specific model, please consult factory.

**Note:** IE20WCPHE & IE30WCPHE both for MVOLT and HVOLT battery packs.

**EMERGENCY LUMENS CROSS AFL GND (5000K, 80CRI)**

		IE20WCPHE	IE30WCPHE
SEF	12000	3900	5800
	15000	3900	5800
	18000	3900	5800
	24000	4000	6000
	30000	4000	6000
	36000	4000	6000
	48000	4000	6000
60000	4000	6000	



**EMERGENCY OPERATION SCENARIOS**

	Standard Sensor or Control Device (commonly used with Battery Pack Option)	EM Solution (Used when switching single incoming hot to generator power)	ER Solution (Used when switching to generator power via a 2nd hot lead)
<b>Emergency Lighting Strategy</b>	*Luminaire-integral battery pack and emergency driver *Generator transfer device	*Diesel genset emergency backup supply *Slow transfer inverter (>30ms) emergency backup supply	*Fast Transfer (FT) inverter emergency backup supply *Uninterruptible Power System (UPS) emergency
<b>Recommended Control Device Option</b>	*Not specifically listed for emergency use. *Wired such that a separately listed emergency device provides emergency lighting power and/or control during loss of normal power scenarios.	*UL 924 listed *EM devices will remain at their high-end trim and ignore wireless lighting control commands, such as in the event of a normal power failure, unless a normal-power-sensed (NPS) broadcast is received at least every 8 seconds. *Using the CLAIRITY+ mobile app, EM devices must be associated with a group that includes a normal power sensing device to receive NPS broadcasts. *Only non-emergency rPP20, rLSXR, rSBOR, rSDGR, and nLight AIR luminaires with version 3.4 or later firmware can provide normal power sensing for EM devices. See specification sheets for control devices and luminaires for more information on options that support normal power sensing.	*UL 924 listed *Utilizes dedicated Normal Power sensing leads to initiate lighting control override during loss of normal power scenarios. *Requires connections to both emergency and normal power circuits.

	Function	Sequence of Operations	Standard Sensor or Control Device	EM Solution (Generator 1 Hot)	ER Solution* (Generator 2 Hots)	IBG Standard Sensor Settings				
						Vacancy Time Out	Dim to Off Time Delay	High Trim	Low Trim (Vacancy Dim Level)	Photocell Set Point
<b>Standalone Sensors</b> (Individual control per fixture)	On/Off	Lights turn on when motion detected; Upon vacancy, Lights turn off after timeout.	LSXR6	-	LSXR6 ER	10 min	-	-	-	-
	High/Low (Off)	"Lights turn on to high trim when presence is detected; Upon vacancy, the lights dim to low trim after timeout and turn off after "Dim To Off" Time Delay. For High/Low (Never Off) function, bypass the relay by bringing power directly into driver rather than wiring hot through LSXR device."	LSXR6 HL	-	LSXR6 HL ER	10 min	2.5 min	100%	"10% (Driver Low)"	-
	Photocell	Lights turn on unless ambient light level is above set point; If ambient light levels in the space exceed the photocell set point, lights will turn off even during occupancy.	LSXR6 P	-	LSXR6 P ER	-	-	-	-	4 fc
	Dimming + Photocell	Lights turn on when presence is detected unless ambient light level is above set point; Upon vacancy, the lights dim to low trim, then turn off after timeout; During occupancy, automatically raise and lower electric light level to maintain set point and turn off, depending on ambient light.	LSXR6 ADC	-	LSXR6 ADC ER	10 min	2.5	-	-	4 fc
	Dimming + Photocell + High/Low	Lights turn on when presence is detected unless ambient light level is above set point; Upon vacancy, lights dim to low trim after timeout and remain at low trim until presence is detected; Automatically raise and lower electric light level to maintain set point during occupancy and during vacancy keeps lights at low trim if ambient light is not sufficient.	LSXR6 ANL	-	LSXR6 ANL ER	10 min	-	100%	10%	4 fc
Note: For 360° integral Low Mount sensors, replace "6" in nomenclature with "10". Ex. LSXR10 P. For High Aisle Mount sensors, replace "6" with "50".										

<b>Bluetooth Sensors</b> (Configurable via mobile Bluetooth app)	On/Off	Lights turn on when motion detected; Upon vacancy, Lights turn off after timeout.	HLN45 OCC	-	HLN45 OCC ER	10 min	-	-	-	-
	High/Low (Off)	Lights turn on to high trim when presence is detected; Upon vacancy, the lights dim to low trim after timeout and turn off after "Dim To Off" Time Delay.	HLN45 HL	-	HLN45 HL ER	10 min	2.5 min	100%	10%	-
	Dimming + Photocell	Lights turn on when presence is detected unless ambient light level is above set point; Upon vacancy, the lights dim to low trim during timeout; During occupancy, automatically raise and lower electric light level to maintain set point and turn off, depending on ambient light.	HLN45 ADC	-	HLN45 ADC ER	10 min	2.5 min	-	10%	50 fc
	Dimming + Photocell + High/Low (Never Off)	Lights turn on when presence is detected unless ambient light level is above set point; Upon vacancy, lights dim to low trim after timeout and remain at low trim until presence is detected; Automatically raise and lower electric light level to maintain set point during occupancy and during vacancy keeps lights at low trim if ambient light is not sufficient.	HLN45 ANL	-	HLN45 ANL ER	10 min	Never off due to occupancy	100%	10%	50 fc
Note: For High Aisle Mount sensors, replace "45" in nomenclature with "45A". Ex. HLN45A HL										

<b>nLight wired Networked Controls</b>	Dimming + Photocell + Occupancy	Programmable network sensor - On/Off Occupancy detection with Dimming (includes dimming powerpack externally mounted to fixture access plate)	NCMB6	-	NCMB6 ER	10 min	7.5 min	100%	10%	5 fc
	Dimming	Programmable On/Off control only with dimming - no sensor (device externally mounted to fixture access plate)	NPP16 D	-	NPP16 D ER	-	-	100%	1%	-
Note: For 360° integral Low Mount sensors, replace "6" in nomenclature with "10". For high Aisle Mount sensors, replace "6" with "50". Ex: NCMB50										

<b>nLight AIR Wireless Sensors</b>	Dimming + Photocell + Occupancy	Wirelessly programmable network sensor - On/Off control with dimming, occupancy detection, and daylight harvesting (Sensor embedded in fixture)	NLTAIR2 RMSOD45	RLSXR 6 EM	NLTAIR2 RMSOD45 ER	7.5 min	-	100%	30%	50 fc
	Dimming	Wirelessly programmable On/Off control with dimming - no sensor (Device embedded in fixture)	NLTAIR2 RIO	RPP20D EM	NLTAIR2 RIO ER	-	-	100%	10% (driver low)	-
Note: For 360° integral Low Mount sensors, replace "45" in nomenclature with "7". For high Aisle Mount sensors, replace "45" with "45A". Ex: NLTAIR2 RMSOD45A EM sensors/controls are KO-mounted; all others integral. RPP20 D EM de-rates fixture to Damp Location.										

**\*All ER solutions except nLight wired, include standard sensor or control device with a factory-installed Iota ETS##-DR (UL924 bypass device). This device is integral to the fixture and will include a hot and neutral lead for the dedicated emergency circuit.**

**JOB PACK QUANTITIES**

Series	Performance	Lumens	Job Pack Quantities			
			Standard / Base configuration	With Sensor, Cord Set, or RELOC	With Wire guards	With Battery
IBG	SEF	8000LM	90	60	60	48
		12000LM				
		15000LM				
		18000LM	64	40	40	32
		24000LM				
		30000LM				
		36000LM	52	32	32	28
		48000LM	30	24	20	14
	60000LM	26	18	18	14	
	72000LM					
	HEF	8000LM	90	60	60	48
		12000LM	64	40	40	32
		15000LM				
		18000LM	52	32	32	28
		24000LM				
		30000LM				
36000LM		26	18	18	14	
48000LM						
60000LM						
72000LM						

<b>Breakout Example:</b>		
<b>Ordered Line:</b>	Qty: 90	IBG 24000LM SEF AFL GND MVOLT GZ10 50K 80CRI LSXR6 DWH JP *Above configuration shows 40 units for Job Pack
<b>Breakout Line 1:</b>	Qty: 80	IBG 24000LM SEF AFL GND MVOLT GZ10 50K 80CRI LSXR6 DWH JP40 *Will have 2 pallets of 40 units each
<b>Breakout Line 2:</b>	Qty: 10	IBG 24000LM SEF AFL GND MVOLT GZ10 50K 80CRI LSXR6 DWH *Balance will ship in unit cartons

Note: If quantity ordered is less than Job Pack quantity for that configuration, the breakout line will default to unit packs.

**nLIGHT AIR SENSOR - RMSOD**

**nLIGHT® AIR Dimming and Photo Sensor**

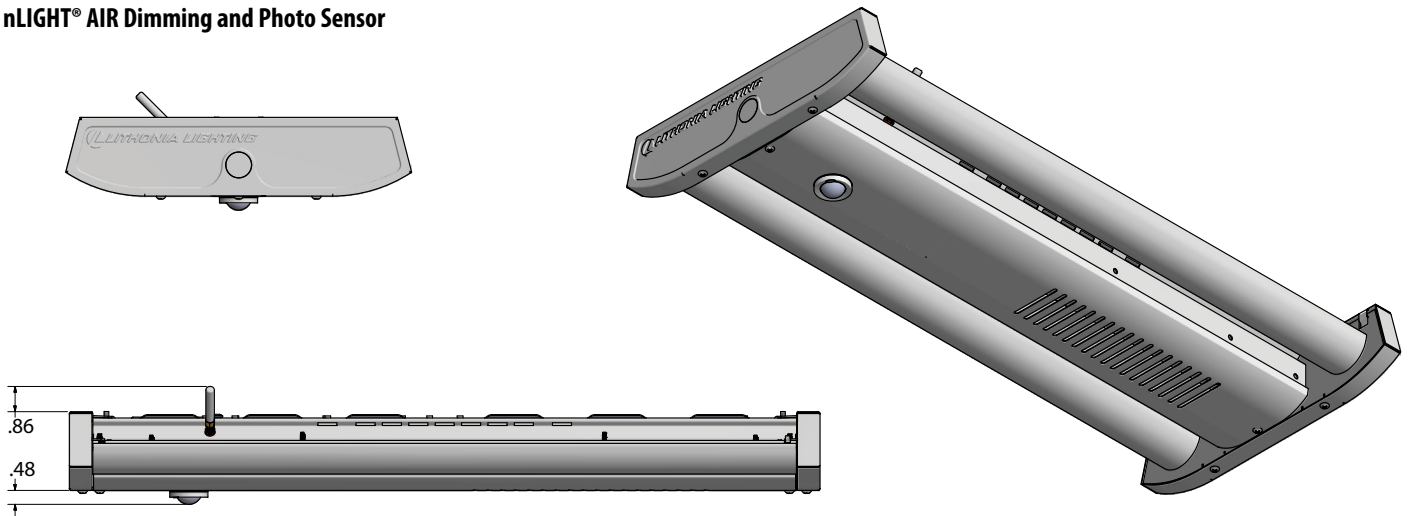

**7 - MINI-LOW BAY 360° LENS**

- Recommended for walking motion detection from mounting heights between 8 ft (2.44m) and 20 ft (6.10 m)
- Initial detection of walking motion along sensor axes at distances of 2x the mounting height up to 15 ft (4.57 m) and 1.75x up to 20 ft (6.10 m)
- Provides 12 ft (3.66 m) radial detection of small motion when mounted at 9 ft (2.74)
- Initial detection will occur earlier when walking across sensor's field of view than walking directly at sensor

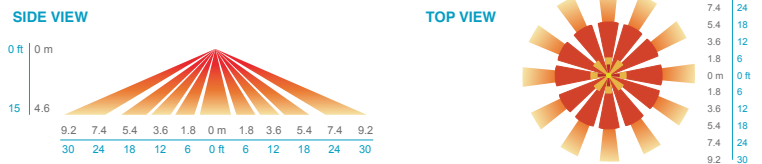

**45- HIGH MOUNT 360°**

- Optimized full coverage pattern for 10 – 40 ft. (3.1 – 12 m)
- Reliable detection of large motion (e.g. pedestrian walking traffic) up to 30 ft. (9.1 m) mounting height
- Reliable detection of extra-large motion (e.g. forklift traffic) up to 40 ft. (12 m) mounting height

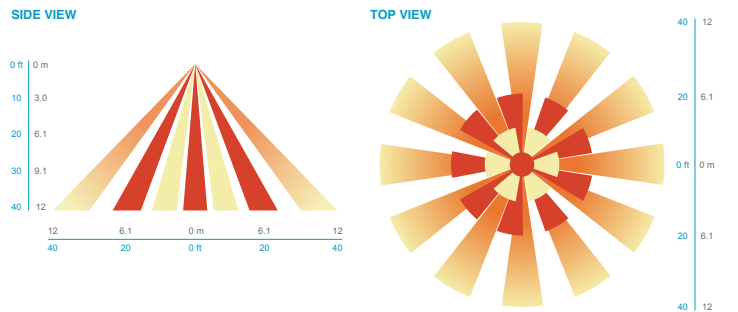

**45A HIGH MOUNT AISLEWAY**

- Optimized bi directional coverage pattern for aisleyways with 10 – 40 ft. (3.1 – 12 m) mounting heights
- 1.5X's mounting height equals approximate detection range
- Reliable detection of large motion (e.g. pedestrian walking traffic) up to 30 ft. (9.1 m) mounting height
- Reliable detection of extra-large motion (e.g. forklift traffic) up to 40 ft. (12 m) mounting height

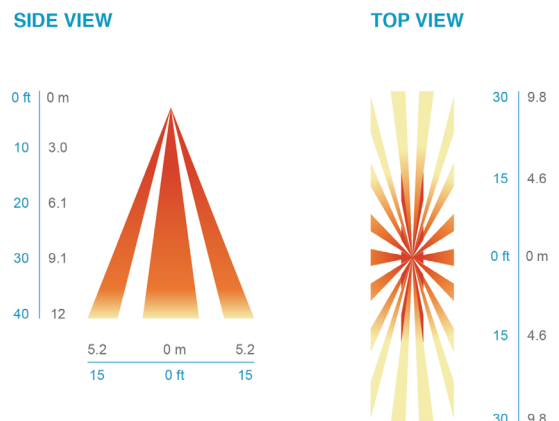

### HALEON - Integrated Occupancy Sensor with Bluetooth® Programmability

- Programmable sensor settings over Bluetooth® with Acuity VLP smartphone app.
- Default programming options to service various application spaces - occupancy detection, 0-10V dimming and daylight harvesting.
- 360° High Mount and High Mount Aisleway lens detection options for mounting heights up to 40 ft.
- Integrated retractable lens mask included to block unwanted detection.
- Sensor ambient temperature rating of -40°F (-40°C) to 158°F (70°C).



### Haleon Default Programming

Model	Default Operation	LSXR Equivalent	Occupancy Time Delay	Photocell Mode	Photocell Set-point	Low Trim	High Trim	Dim to Off Time Delay
HLNxxx	On/Off Occupancy Only	LSXR6 LT or LA00STU	10 minutes	Disabled	n/a	n/a	100%	Disabled
HLNxxx HL	Occupancy w/ 0-10V Dimming (High/Low/Off)	LSXR6 HL LT or LAHOSTU	10 minutes	Disabled	n/a	10%	100%	2.5 minutes
HLNxxx ADC*	Occupancy w/ Dim & Switch Photocell	LSXR6 ADC LT or LAM0STU	10 minutes	On/Off & Auto Dim	50 fc	10%	100%	2.5 min
HLNxxx ANL	Dim & Switch Photocell with High/Low Occupancy Operation	LSXR6 ANL LT or LAG0STU	10 minutes	On/Off & Auto Dim	50 fc	10%	100%	Stay Dim/ Never off due to occupancy

Note: Lens detection noted in place of 'xxx'

\*HLN ADC includes a 2.5 minute dim to off not found in LSXR ADC.

### HALEON COVERAGE PATTERNS

#### 45- HIGH MOUNT 360°

- Optimized full coverage pattern for 10 – 50 ft. (3.1 – 12 m)
- Reliable detection of large motion (e.g. pedestrian walking traffic) up to 30 ft. (9.1 m) mounting height
- Reliable detection of extra-large motion (e.g. forklift traffic) up to 40 ft. (12 m) mounting height
- Stow-able rotating lens shield can be utilized to mask areas in which detection is not desired

SIDE VIEW

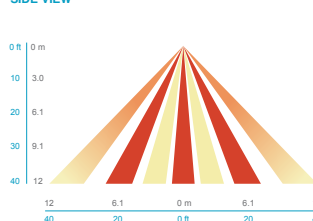

TOP VIEW



#### 45A HIGH MOUNT AISLEWAY

- Optimized bi directional coverage pattern for aisleways with 10 – 50 ft. (3.1 – 12 m) mounting heights
- 1.2X's mounting height equals approximate detection range
- Reliable detection of large motion (e.g. pedestrian walking traffic) up to 30 ft. (9.1 m) mounting height
- Reliable detection of extra-large motion (e.g. forklift traffic) up to 40 ft. (12 m) mounting height
- Stow-able rotating lens shield can be utilized to mask areas in which detection is not desired

SIDE VIEW

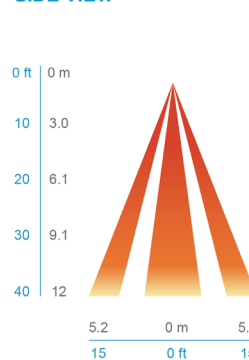

TOP VIEW

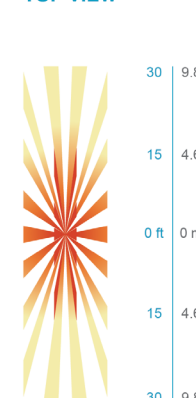

## LSXR — Fixture Mount Occupancy Sensor (see [www.AcuityControls.com](http://www.AcuityControls.com) for additional information)

- Three interchangeable lens options to satisfy multiple mounting heights and coverage pattern requirements.
- Integrated mounting bracket drops lens down 3" from chase nipple.
- Single or dual relay versions — designed with robust protection from the harsh switching requirements of T5 and LED loads.
- Photocell and 0-10VDC dimming options.
- No PIR field calibration or sensitivity adjustments required.
- Sensor ambient temperature rating of 14°F (-10°C) to 131°F (55°C).

LSXR configuration	Comparable CMRB sensor	Old style sensor nomenclature
<b>For shortest lead times use one of the following LSXR configurations</b>		
LSXR50 / LCOZU	CMRB 50	MSI
LSXR50 HL / LCHOSZU	CMRB 50 D	MSID
LSXR50 P / LCPZU	CMRB 50 P	MSIPED
LSXR6 / LAOZU	CMRB 6	MSI360
LSXR6 HL / LAHOSZU	CMRB 6 D	MSI360D
LSXR6 P / LAPZU	CMRB 6 P	MSI360PED



## LSXR COVERAGE PATTERNS

### HIGH MOUNT 360° LENS (#6)

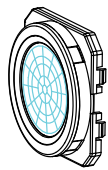

- Best choice for 15 to 45 ft (4.57 to 13.72 m) mounting heights
- 15 to 20 ft (4.57 to 6.10 m) radial coverage overlaps area lit by a typical high bay fixture
- Excellent detection of large motion (e.g. walking) up to a 35 ft (10.76 m) mounting height
- Excellent detection of extra large motion (e.g. forklifts) up to a 45 ft (13.72 m) mounting height

LOW VIEW

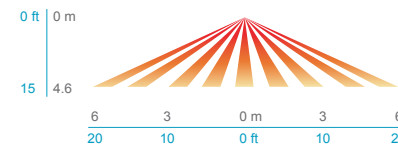

HIGH VIEW

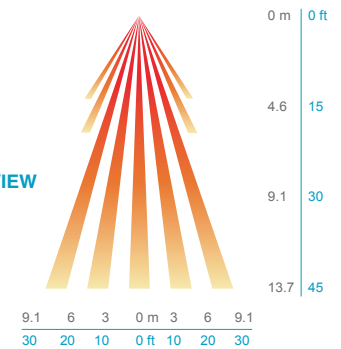

### HIGH MOUNT AISLEWAY LENS (#50)

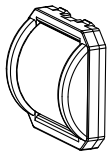

- Provides a bi-directional coverage pattern ideal for warehouse racking
- 1.2x mounting height equals approximate detection range in either direction
- Typical 40 ft (12.19 m) mounting detects 50 ft (15.24 m) in either direction
- Superior aisleway coverage compared to a masked 360° lens

SIDE VIEW

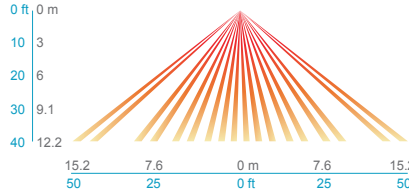

TOP VIEW

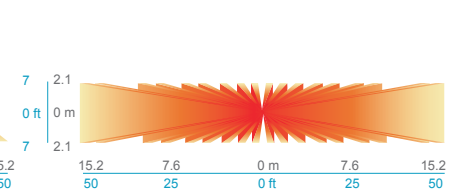

### LOW MOUNT 360° LENS (#10)

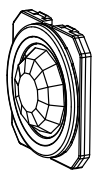

- Best choice for large motion detection (e.g. walking)
- 360° conical shaped pattern
- Provides ~24 ft (7.32 m) radial coverage (~2000 ft<sup>2</sup>) when mounted at 9 ft (2.74 m)
- 7 to 15 ft (2.13 to 4.57 m) mounting heights provide 16 to 36 ft (4.88 to 10.97 m) radial coverage
- Detection range improves when walking across beams compared to into beams

SIDE VIEW

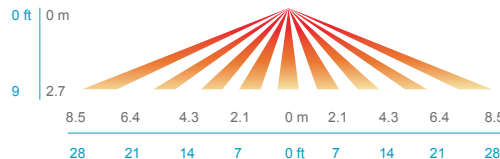

TOP VIEW

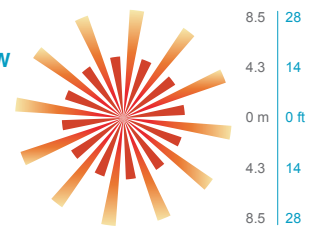



**RMSOD**

- 100% digital PIR detection
- Combined daylight and occupancy sensor
- Fully dimmable via digital or analog dimming protocols, providing the right amount of light for the application and to optimize energy savings
- Optional UL 924 emergency functionality via EM option, which eliminates wiring for sensing normal power

**COVERAGE PATTERN**

Lens rotates 15 deg to enable adjustment. Initial detection will occur earlier when walking across sensor's field of view than when walking directly at sensor.

**7 - MINI LOW-BAY 360°**

- Recommended for walking motion detection from mounting heights between 8 ft (2.44 m) and 20 ft (6.10 m)
- Initial detection of walking motion along sensor axis at distances of 2x the mounting height up to 15 ft (4.57 m) and 1.75x up to 20ft (6.10 m).
- Provides 12 ft (3.66 m) radial detection of small motion when mounted at 9 ft (2.74 m)

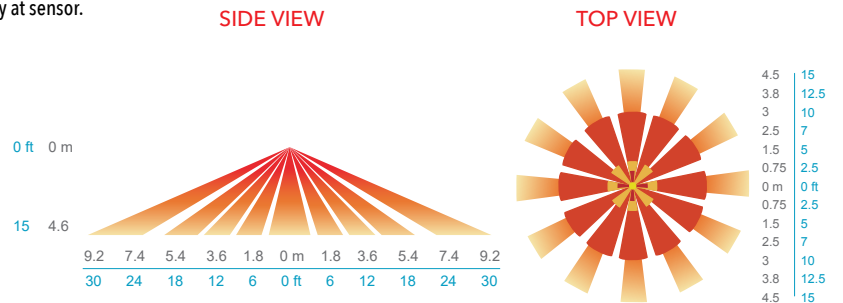

**30 - UNIVERSAL 360°**

- Provides excellent detection of large motion (e.g. walking) when mounted between 15 to 40 ft (4.57 to 12.19 m)
- 15 to 20 ft (4.57 to 6.10 m) radial coverage overlaps area lit by a typical high bay fixture
- Recommended for fixtures that have a 1:1 spacing to mounting height ratio or less (e.g. fixtures 30' on center or less @ a 30' mounting height.)

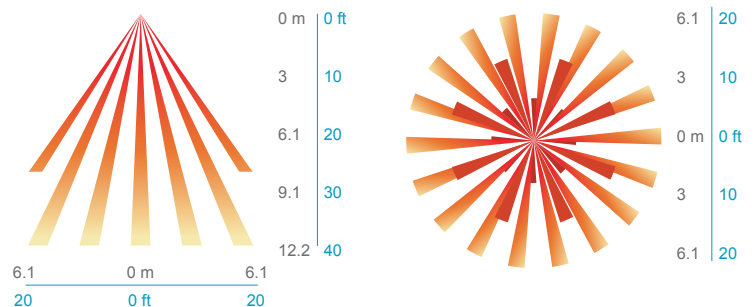

**45 - HIGH MOUNT 360°**

- Optimized full coverage pattern for 10 - 40 ft. (3.1 - 12 m)
- Reliable detection of large motion (e.g. pedestrian walking traffic) up to 30 ft. (9.1 m) mounting height
- Reliable detection of extra-large motion (e.g. forklift traffic) up to 40 ft. (12 m) mounting height

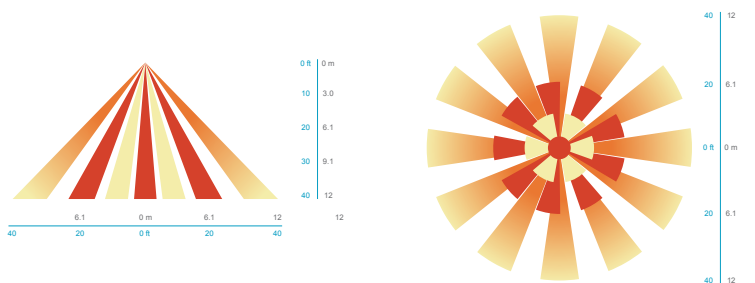

**45A - HIGH MOUNT AISLEWAY**

- Optimized bi directional coverage pattern for aiseways with 10 - 40 ft. (3.1 - 12 m) mounting heights
- 1.5x's mounting height equals approximate detection range
- Reliable detection of large motion (e.g. pedestrian walking traffic) up to 30 ft. (9.1 m) mounting height
- Reliable detection of extra-large motion (e.g. forklift traffic) up to 40 ft. (12 m) mounting height

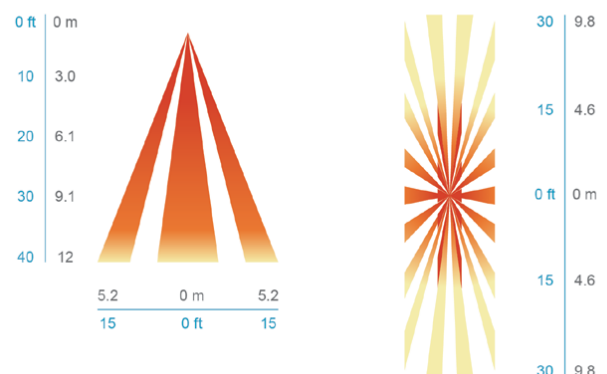

### IMP - Integrated Modular Plug

- The integrated modular plug (IMP) option allows the installer to plug and play a multitude of accessories.
- Cord sets connect quickly to any fixture with IMP option.
- IMP accessories include occupancy sensors, photocells, X-point relays.

IMP compatible cord sets <sup>1</sup>	
CS1WIMP	Straight plug, 120V
CS3WIMP	Twist-lock, 120V
CS7WIMP	Straight plug, 277V
CS11WIMP	Twist-lock, 277V
CS25WIMP	Twist-lock, 347V
CS93WIMP	600V SE00W white cord, no plug
CS97WIMP	Twist-lock, 480V

IMP compatible sensors	
MSIIMP	Aisle sensor
MSI360IMP	360° sensor

#### Ordering Example

Order As: Qty 1 - IBG 12000LM SEF AFL GND 120 GZ10 40K 80CRI IMP CP5BW DWH  
 Ships As: Qty 1 - IBG 12000LM SEF AFL GND MVOLT GZ10 40K 80CRI DWH  
 Qty 1 - CS1WIMP

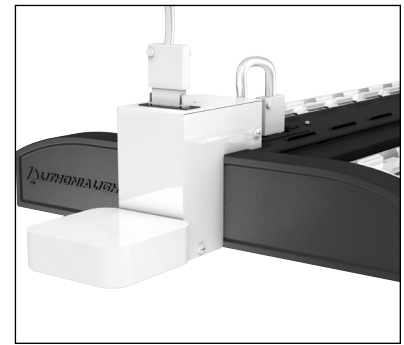

#### Notes

- 1 Cord set required for fixture operation. All cord sets are 18/3, 6' white.

### RRL - RELOC®-Ready Luminaire

- RRL connectors to be used with the OnePass system.
- Load side of connector factory installed to luminaire.
- 4-pole mating connector with push-in terminations allows for simple installation.
- Touch-safe design on both halves meets UL/CSA requirement.
- Wiping contact design allows safe disconnect under load.



#### ORDERING INFORMATION

Lead times will vary depending on options selected. Consult with your sales representative.

**Example: RRLA**

Series	Wiring instructions
RRL RELOC®-ready luminaire	A Hot conductor wired to position #1 (phase A); non-dimming B Hot conductor wired to position #2 (phase B); non-dimming AE Hot conductor wired to position #1 (phase A), hot conductor #2 wired to position #2 (phase B); non-dimming <sup>1</sup> C12S Hot conductor in position #1 (phase A), low voltage conductor #1 in position #2, low voltage conductor #2 in position #3; dimming <sup>2</sup>

### Compatible RELOC® Cables for Industrial Luminaires (ordered and shipped separately)

(click to view RELOC product page for more information)



#### Notes

- 1 AE commercial fixtures should disconnect the TSPL before unplugging the RRL so it does not go into discharge mode. Requires fixture to have battery option.
- 2 C12S option is used with the OnePass for 0-10V/DALI applications. Not for use with dimming sensors.